

HYDRAULIC PUMP HY85/180

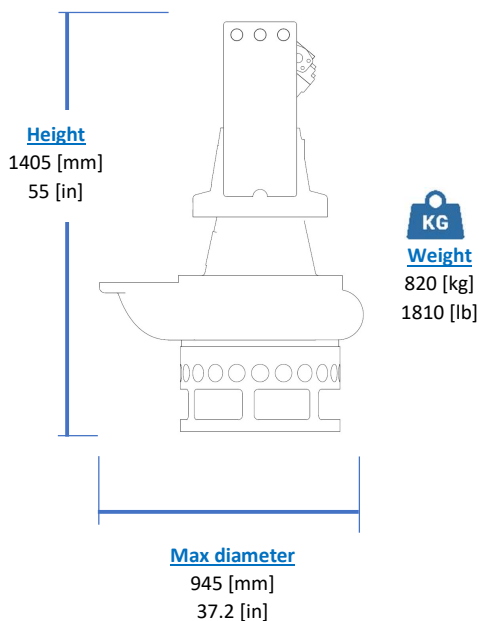
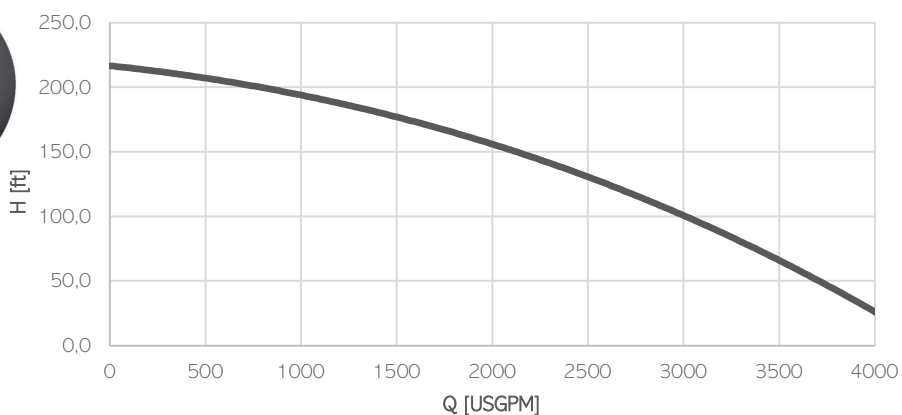
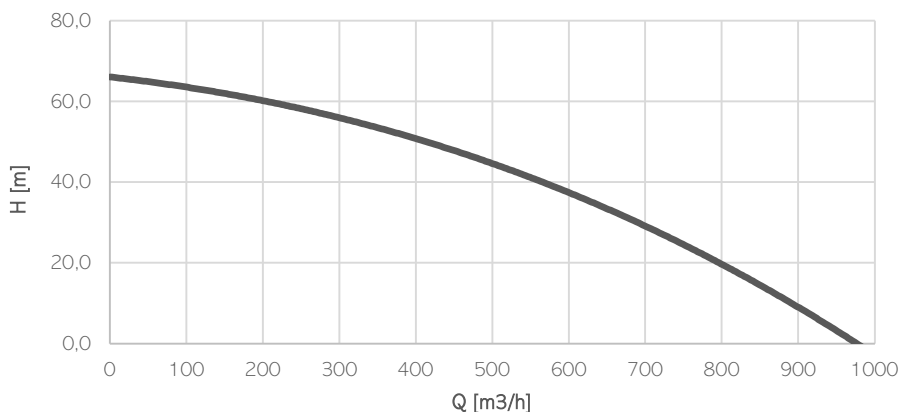

Model	HY85/180
Brake Power [kW HP]	130 170
Efficiency [%]	51
RPM Max	1450
Motor Displacement [cc]	160
Oil flow rate max [l/min]	260
Nominal pressure [bar]	300
Max pressure [bar]	350
Solid handling [mm in]	60 2.4
Discharge [DN PN]	200 PN10

Materials

Part	Standard
Casing	Cast Iron EN-GJS500
Body	Cast Iron EN-GJL250
Wear Parts	High chrome EN-GJN-HV600 (CH6)
Minimum hardness [HB]	550
Main shaft	High tensile 39NiCrMo3
PH Range	5-10

Seals and lubricants

Version	HY85/180	MG	MS
Motor Side	LIPS	MECHANICAL	MECHANICAL
Impeller Side	LIPS	LIPS	MECHANICAL
Oil type	EP320	ISO32	ISO32

Ports

- | Service line Ports: SAE J518 1 1/4in
- | Case drain Port: DIN3852 M22x1,5

Operating Conditions

- | Max liquid temperature 40°C
- | Min Submersion depth 440mm